

Brabender: Measuring and Processing Die Heads and Follow-Up Equipment

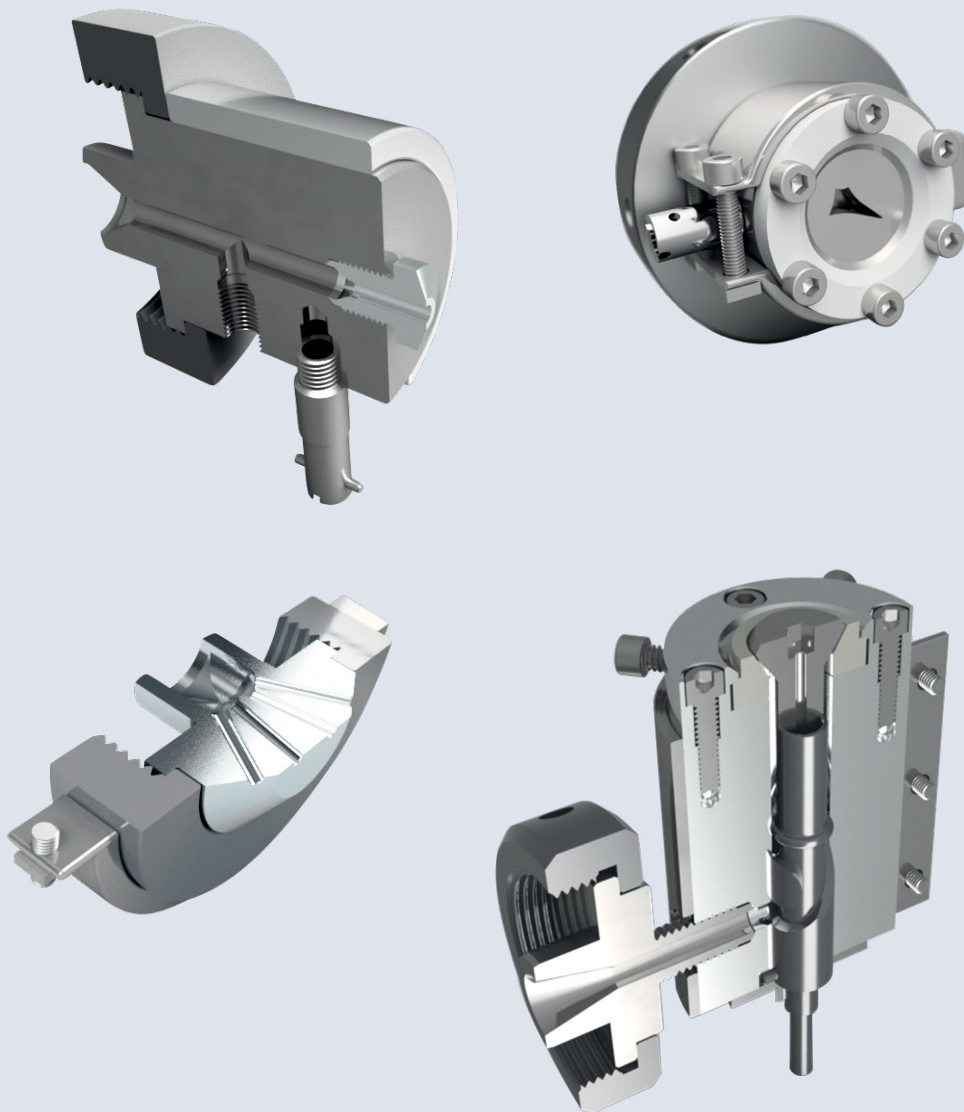

Versatile
Precise
Easy to handle

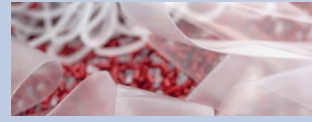

Brabender measuring die heads are high-precision tools fitting all of the Brabender single and twin screw extruders. They are used to produce special extrudate shapes that can be further examined or to simulate production processes in order to find out the optimum material recipe and process parameters for this process. Temperature and pressure transducers which are frequently mounted in the die head provide reliable data concerning the material behavior in the die head.

Mounting and interchanging them at the extruder barrel is quick and easy through a ring nut coupling. The die heads are heated electrically and form a separate control zone triggered by the temperature control unit. They are made of corrosion-proof steel and can be disassembled for easy cleaning.

Upon request, special constructions are available, such as liquid heating/cooling, non-standard sizes or special materials.



Brabender application laboratory

The Brabender support

Our state of the art application Laboratory is always made available to our customers.

You can choose to send material to us for testing or schedule a specific Lab Trial with our expert team. Customers will have access to our full product line to help come to a solution for their application.

Measuring and Processing Die Heads

Use the versatile Brabender measuring extruders and the extensive line of measuring and processing die heads. Extrude numerous types of plastics and materials such as thermoplastics, thermosets, ceramic binder systems and elastomers.

Analyze your material on a laboratory scale, in real conditions, for various criteria, e.g.

- Uniform plastification, gels, surface gloss
- Color dispersion and color check
- Transparency and formation of streaks
- Swelling and contraction behavior
- Segregation of individual recipe components of a compound at the die and/or at the screw tip (e.g. titanium dioxide)
- Output per unit of time
- Rheological properties, etc.

Processing die heads

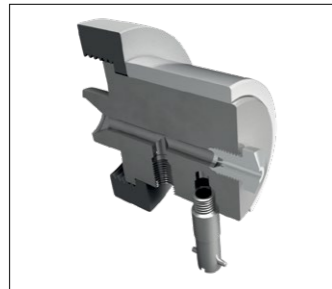

Round strand die

The single round strand die head is designed to accommodate nozzle inserts of different diameters in order to allow for variation of the strand diameters without needing to change the entire die head.

Round strand die head

Strand diameters	0.5 - 8 mm, others on request
------------------	-------------------------------

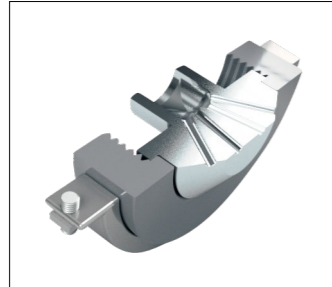

Multi strand die

Multi strand dies are capable of extruding several round strands at a time and can help enhancing your extrusion capacity.

Multi strand die

Number of strands	2 - 4
Strand diameters	1 - 6 mm, others on request

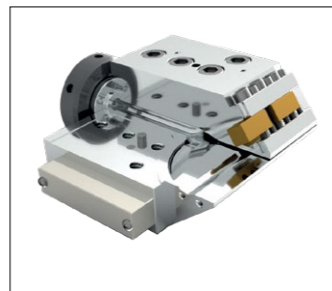

Ribbon die head

Brabender supplies various designs of ribbon die heads to match a large variety of applications:

- "Fishtail" design with fixed gap
- "Fishtail" design with adjustable gap
- "Coathanger" design with flex-lip

All of the ribbon die heads are available with different gap widths and openings to obtain a large variety of sheet dimensions.

Of course, special designs are available upon request as well.

Ribbon die head

"Fishtail" with fixed gap	Widths:	20 - 200 mm
	Gap:	0.05 - 3.0 mm
"Fishtail" with adjustable gap	Widths:	50 / 75 / 100 / 150 / 200 mm
	Gap ranges:	0 - 1.5 / 2.0 / 3.0 mm
"Coathanger" with flex-lip	Widths:	50 / 100 / 150 mm
	Gap ranges:	0.05 - 1.0 / 1.5 mm

Processing die heads



Film blowing die head

Both pinole and spiral mandrel designs are available. The pinole type die heads are designed to accommodate die

inserts of different sizes according to the desired bubble diameter. Co-extrusion dies are also available on request.

Film blowing die head

Outer/inner diameter	ø 26 mm / ø 25 mm
• Pinole	ø 36 mm / ø 35 mm, others on request
• Spiral mandrel die head	ø 26 mm / ø 25 mm ø 50 mm / ø 48.5 mm, others on request



Garvey die head

This die head was specially developed for the rubber and tire manufacturing industries in order to observe the appearance and contours of the extrudate. The special shape of the die

outlet opening, combining relatively flat surfaces, sharp corners, and thin sections, reproduces typical geometries in tire building blocks and fully complies with ASTM 2230.

Garvey die head

Geometry	according to ASTM D 2230 standard
----------	-----------------------------------

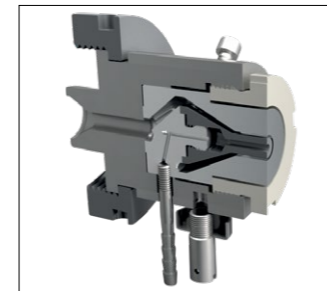

Tubing die head

The tubing die head is designed to produce tubes or hoses. Nozzle inserts of different sizes can be mounted

to achieve different diameters and wall thicknesses without needing to change the entire die head.

Tubing die head

Outer hose diameters	0.8 - 30 mm, others on request
Wall thicknesses	0.2 - 12 mm, others on request



Wire coating die head

With the wire coating die head, polymeric coatings can be extruded on wires of different diameters. This die head can

perfectly be combined with the Brabender Wire Take-off Unit to obtain a laboratory-scale wire production line.

Wire coating die head

Wire diameter	max. 1.6 mm
Coating thickness	max. 0.8 mm

Measuring and Processing Die Heads

Die heads for rheological tests

Extend your possibilities

Using rheometric capillary die heads, you can extend the possibilities of your single screw extruder and use it for running rheological tests. On the basis of the resulting flow curve or viscosity curve which mirrors the rheological characteristics of your polymer melts, in particular their viscosity behavior in a practice-oriented range of shear rates, you can easily optimize the individual processing steps in your production.

Principle

The principle is based on the direct measurement of the melt pressure drop in the die head. Unlike with piston type capillary rheometers, the melt is transported continuously by the extruder screw and, possibly, a melt pump to the capillary die head. The apparent – and later on true viscosity can be calculated by measuring the wall shear

stress due to the pressure drop in a given geometry and the shear rate by measuring the volume flow and providing the specific melt gravity of the material. The software enables the customer to apply industry standard correction factors (i.e. Rabinowitch) to calculate the true viscosity. The software also provides several approximation models how to interpret the measured viscosity (Power law, Carreau).

For the round capillary viscosity test, the software can be used to even out the pressure loss due to the running-in of each capillary insert according to Bagley.

Advantages

- Continuous operation
- Coverage of the occurring shear rate range
- Accurate viscosity and shear rate data with the corresponding corrections calculated by the software
- All acquired values are suitable to evaluate the shear and thermal stability of your material

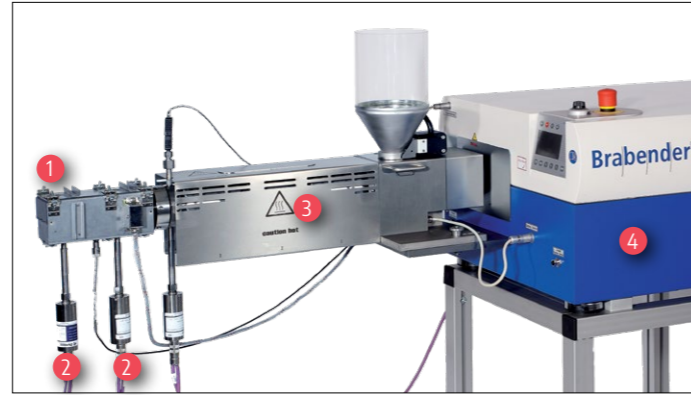
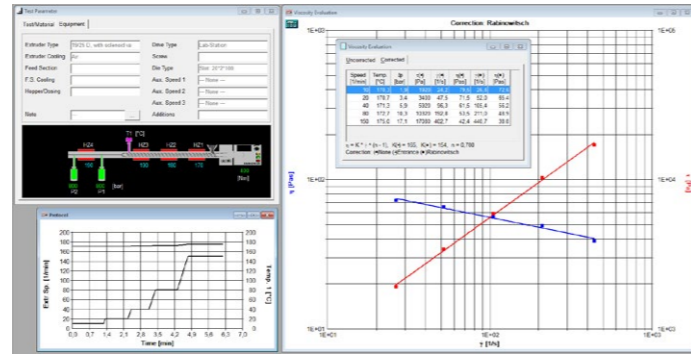

Extruder 19/25 with slot capillary die head

Instrumentation for rheological tests

The figure above shows, as an example, an extrusion line for rheological tests which features the following main components:

- 1 Slot capillary die head
- 2 Pressure transducers in the die head for measuring the pressure drop in the die head
- 3 Measuring extruder 19/25
- 4 Metastation 4/8/16 or recent units, here: Plastograph EC Plus

Slot capillary die head	
Slot capillary dimensions (width x height x length)	Shear rate
20 x 0.8 x 160 mm	$2 \times 10^1 - 1 \times 10^3 \text{ s}^{-1}$
20 x 2.0 x 160 mm	$4 \times 10^0 - 1 \times 10^2 \text{ s}^{-1}$

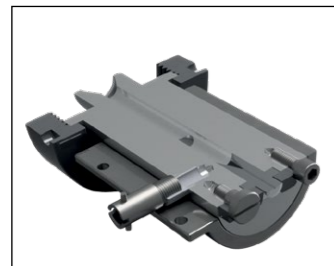

Rheometric round capillary die head

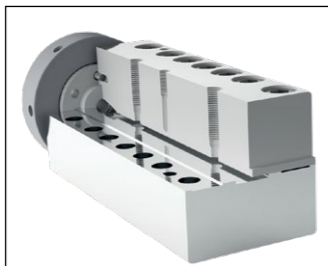

Rheometric slot capillary die head

Round capillary die head

Round capillary dimensions (diameter x length)	Shear rate	Round capillary dimensions (diameter x length)	Shear rate
$\varnothing 1 \times 15 \text{ mm}$ $\varnothing 1 \times 20 \text{ mm}$ $\varnothing 1 \times 30 \text{ mm}$	$5 \times 10^2 - 2 \times 10^4 \text{ s}^{-1}$	$\varnothing 3 \times 18 \text{ mm}$ $\varnothing 3 \times 24 \text{ mm}$ $\varnothing 3 \times 30 \text{ mm}$	$3 \times 10^1 - 8 \times 10^2 \text{ s}^{-1}$
$\varnothing 2 \times 20 \text{ mm}$ $\varnothing 2 \times 30 \text{ mm}$ $\varnothing 2 \times 40 \text{ mm}$	$7 \times 10^1 - 3 \times 10^3 \text{ s}^{-1}$	$\varnothing 4 \times 24 \text{ mm}$ $\varnothing 4 \times 32 \text{ mm}$ $\varnothing 4 \times 40 \text{ mm}$	$8 \times 10^0 - 3.5 \times 10^2 \text{ s}^{-1}$

Swelltest

Minimize rejected or off-spec material

Swelling of the extrudate at the die outlet causes loss in quality of your product and rejects. Avoid such risks using the Brabender Swelltest for measuring the diameter of your extruded strands – precisely, contact-free, and continuously.

The Brabender Swelltest provides:

- High-speed, high-accuracy, non-contact measurement of the diameter of objects with a circular cross-section by means of high-intensity GaN green LED light
- Continuous diameter measurement on round profiles
- High-speed scanning with 2400 scans/min
- Repeat accuracy of $\pm 0.15 \mu\text{m}$

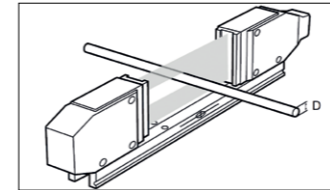

Measuring principle: a projected GaN green LED beam is interrupted by the extrudate

Procedure

The high-intensity GaN green LED radiates light which is converged into a parallel beam by the transmitter lens. This parallel beam passes through the measuring area before it meets a high-speed linear CCD in the receiver.

During processing, the extrudate runs through the measuring sector. When the light beam meets the extrudate, its cross-section is interrupted. This interruption projects a shadow with an area proportional to the diameter of the extrudate on the receiver. The high-speed linear CCD scans and calculates the shadow area from which the sample dimensions are calculated by the controller.

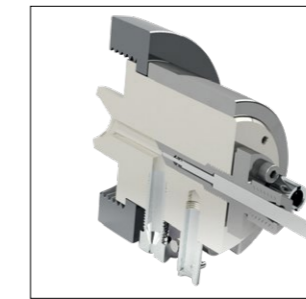

Swelltest die head

Swelltest	
Measuring range	0.3...30 mm
Minimum detectable object	0.3 mm
Light source	GaN green LED
CCD scanning range	approx. 33 mm
Measurement position accuracy	$\pm 2 \mu\text{m}$
Repeating accuracy	$\pm 0.15 \mu\text{m}$
Sampling times	2,400 times/s
Enclosure rating	IP64
Ambient temperature at the sensor head	0 ... 50 °C
Weight	Transmitter: approx. 420 g Receiver: approx. 470 g Base: approx. 430 g

Winder

The full coil can easily be taken off and stored or be used for further tests.

Advantages

The Brabender Winder first of all stands out for its modular and compact design allowing to vary between roll or belt haul-off and providing supports for various types of coils.

- Flexible and easy retrofitting of roll to belt haul-off or vice versa
- Precise setting of the haul-off speed
- Adjustable distance between haul-off and oscillating unit
- Ergonomic control panel
- Easy integration in existing Brabender extruder software



Principle

Complete your extrusion line and wind up your extruded round strands or hoses with the Brabender Winder.

An oscillating unit ensures even and steady winding of the extrudate. The oscillating speed is controlled automatically as a function of the preset haul-off speed and of the extrudate and coil diameters. In order to achieve a perfect winding result, the tension between the nip rolls and the oscillating unit can be adjusted.



Control panel

Winder	
Coil location hole	16 - 305 mm (60 mm or more with rim)
Coil core diameter	60 - 310 mm
Coil flange diameter	max. 400 mm
Coil width	max. 200 mm
Coil weight	max. 15 kg gross
Diameter of round strands	0.5 - 4 mm
Diameter of hoses	0.5 - 12 mm
Haul-off speed	0.2 - 20 m/min
Dimensions (W x H x D)	705 x 1600 x 1200 mm
Weight	approx. 120 kg
Mains connection	3 x 400 V + N + PE, 50/60 Hz, 16 A

Filtratest



the finely woven, multi-layer screen packs of the Filtratest. A pressure transducer in front of the screen packs continuously measures and records the melt pressure in front of the screen packs.

Due to the deposit of foreign particles on the screens, the melt pressure increases. From the start pressure and the maximum pressure of the melt in front of the screen packs, the Filter pressure value (FPV) is calculated automatically:

$$FPV = \frac{(p_{max} - p_s)}{m_c}$$

where

FPV filter pressure value [bar/g]

p_s start pressure [bar]

p_{max} maximum pressure [bar]

m_c pigment quantity in the melt [g]

A subsequent analysis of the deposit on the screens provides additional information as to the kind and amount of polymer impurities.

Advantages

- Quick change of screen packs through drawer system
- Integrated preheating of the screen packs
- Short cycle times and continuous extrusion by by-pass operation of the Filtratest system
- Convenient process and evaluation software

International standard

The Filtratest fully meets the demands of DIN EN 13900-5 and ISO 23900-5 for determining the dispersion and dispersibility of pigments and extenders in plastics by means of the filter pressure value (FPV) test. The main fields of application for this method are quality control of masterbatches, compounds, and polymers as well as color recipe development.

Alternatively, the Filtratest can be used beyond the scope of the standard for testing the purity of polymers.

Principle

The Filtratest is connected to a measuring extruder with a melt pump. The polymer to be tested is plasticized and homogenized in the extruder and conveyed to the melt pump which provides for a constant throughput of the melt through

Filtratest	
Number of inserts	2 sieve package holders 1 flushing ring
Adapter for inserts	8 to 34 mm
Heating	electric heater band, 2000 W, 240 V
Melt pump speed	0 - 50 min ⁻¹
Throughput	50 ... 60 cm ³ /min (acc. to EN 13900-5)
Mains connection	1 x 230 V, 50/60 Hz + N + PE, 16 A

Pressure filter test with sieve pack

Principle

Simple filter method at the screw tip as a combination of perforated plate and filter sieves. Applicable for melt filtration for extrusion

applications with high demands on melt quality. It can be used as a simplified alternative of filter pressure value (FPV) test.



Structure of the pressure filter test consisting of perforated plate and filter sieves



MetaStation 8



MetaStation 4

MetaStation: the role of the drive units

The Brabender drive units

- contain the direct torque measurement system
- control and/or read the parameters of the processing modules, feeders and follow-up units, like melt and zone temperatures, speed, pressure etc.

Univex take-off unit with Film Quality Analyzer (FQA)



Univex with FQA

In-line film quality analysis

The Brabender Univex is a universal haul-off unit for taking off, cooling, and winding up flat films up to a max. film speed of 30 m/min. Liquid temperature conditioning of the nip rolls positively influences e.g. crystallization processes in the film. The winding roll is fixed with clamping cones for easy takeoff.

The Univex can be controlled manually at the control panel or via CAN bus from the PC.

The Univex offers:

- Excellent film quality
- High haul-off speed
- Precise temperature conditioning

Equipped with the Brabender Film Quality Analyzer FQA, the combined system allows for an automated optical in-line analysis of extruded films. The high-resolution camera of the Film Quality Analyzer detects inhomogeneities and impurities (e.g. black specks, gels, fisheyes, holes, etc.) in transparent and pigmented films. Even strongly pigmented films with very low transparencies can be analyzed by means of adaptive transparency and grey level evaluation.

The dedicated software provides an optical analysis of the extruded film and both qualitative and quantitative statistical evaluation of the film purity.

Principle

Each type of inhomogeneity has its own transparency characteristics: a black speck shows another transparency value than a gel or fisheye. These differences in transparency are used to define typical grey levels for each type of inhomogeneity. The camera system recognizes the difference between the grey value level of the undisturbed film and that of inhomogeneities.

Sophisticated software

The versatile evaluation software defines the type of a fault on the basis of its grey value, measures its height and width, calculates the area and a circle diameter corresponding to this area, and allocates it to the corresponding size class. Pictures with detected faults are marked automatically with colored rectangles indicating the type of the fault.

All these data, together with the time when the inhomogeneity occurred, are saved in a database for further evaluation or transfer to Windows® Office applications.

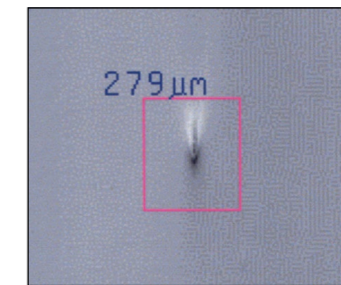

Enlarged image of a detected impurity

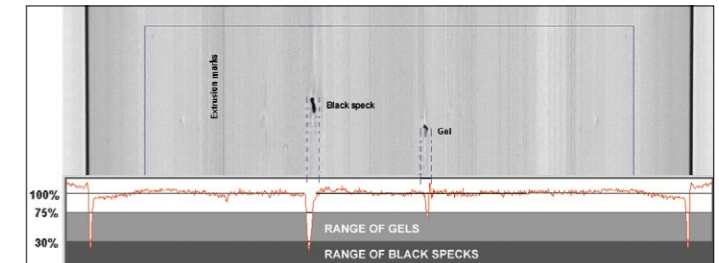

Classification of different types of impurities by grey value level

Film Quality Analyzer	
Sensor type	4096 pixel CCD line camera
Sensor dimensions	41 mm x 10 μm
Pixel dimensions	10 x 10 μm ²
Pixel frequency	80 MHz
Line frequency	approx. 20 kHz
Resolution	approx. 19 μm (depending on haul-off speed)
Width of measuring window	approx. 80 mm
Light source	White LED light
Operating temperature	10 °C to 35 °C
Housing dimensions	145 x 145 x 255 mm
Mains connection	230 V or 110 V, AC, 30 VA

Univex	
Roll assembly	3 nip rolls ø 98.5 mm, 204 mm width
Material	stainless steel, polished (optionally: teflon covered)
Temperature control	liquid (cored rolls), 10 °C ... 175 °C
Nip roll gap adjustment	0 - 8 mm
Winding	1 support for FQA with expander roll, ø 60 mm 2 nip rolls ø 84 mm 1 winding roll ø 84 mm
Speed	infinitely variable 0.2 - 30 m/min
Inverter drive	0.37 kW
Mains connection	1 x 220/230 V, 50/60 Hz + N + PE, 4 A

Follow-Up Equipment

Water bath



For cooling the extruded strands or profiles, mobile water baths of 1000 mm or 2000 mm length are available. They can be adjusted in height to perfectly match the upstream die head.

Conveyor belt



The conveyor belt takes the extruded strands, profiles or sheets directly from the die head, cools them and guides them to any subsequent processing units. It is adjustable in height and equipped with a silicone coated belt to prevent adhering of the extrudate to the belt. For sheet extrusion applications, it can be equipped with a smoothing roll. A compressed cooling channel can be provided for improved cooling of the extrudate.

Pelletizer



The pelletizer stands out for its two separate servo-drives which ensure a constant pellet length even if the intake speed varies. After granulation, the plastic pellets are caught in a drawer or sack and can then simply be removed. Optional extras for this are an interchangeable drawer or secure mounting option for sacks of various sizes. The pelletizer can be controlled manually at the control panel or via CAN bus from the PC.

Blown film take-off unit



The Brabender blown film take-off unit serves for simultaneous blowing, cooling, taking off and winding up of extruded blown films. It has a motor-controlled height adjustment. An ultrasonic diameter control is optionally available. The blown film take-off unit is suited for production simulation under realistic processing conditions and can be expanded with the Film Quality Analyzer FQA to get a complete film processing line including in-line film quality analysis.

Pelletizer

Drive	Feed motor: 0.75-kW servo-motor Cutting motor: 1.9-kW servo-motor
Number of round strands	1 - 4
Strand diameter	1 - 6 mm
Strand speed	0.1 - 30 m/min, infinitely adjustable
Feeding height	1050 mm
Pellet length	0.1 - 20 mm, adjustable
Dimensions (W x H x D)	608 x 1268 x 504 mm
Mains connection	230 V, 50/60 Hz + N + PE, 16 A

Blown film take-off unit

Maximum height	3200 mm
Number of nip rolls	2
Nip roll dimensions	ø 84 mm x 321 mm
Nip roll material	Driven roll: steel Pressure roll: rubber coated
Winder roll	Hard paper core ø 50 mm x 300 mm long
Dimensions (W x H x D)	880 x 3200 x 978 mm
Mains connection	3 x 400 V, 50/60 Hz + N + PE, 16 A

J18IP004EN-A